

Operating and installation instructions

Cooker hood

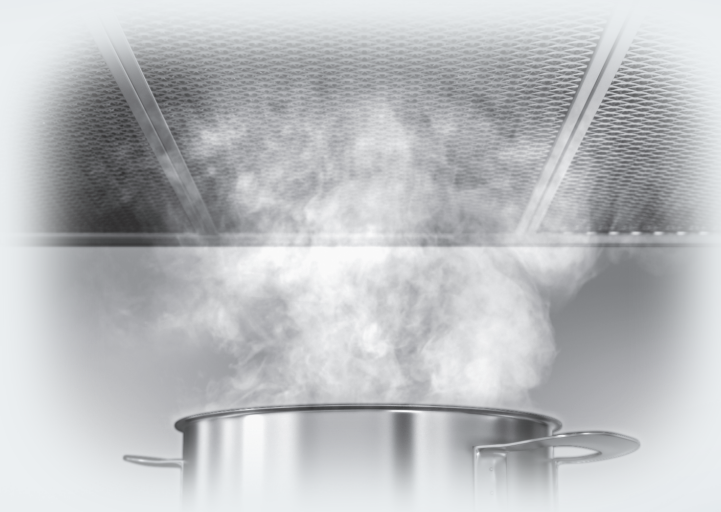

To prevent the risk of accidents or damage to the appliance, it is **essential** to read these instructions before it is installed and used for the first time.

Contents

Warning and Safety instructions	4
Caring for the environment	11
Modes of operation	12
Con@ctivity 2.0 function	13
Guide to the appliance	14
Operation (Automatic mode)	16
Cooking with Con@ctivity 2.0 (Automatic mode).....	16
Leaving automatic mode temporarily.....	18
Returning to automatic mode	18
Operation (Manual mode)	19
Cooking without Con@ctivity 2.0 (Manual mode).....	19
Switch the fan on	19
Select the power level.....	19
Selecting the run-on time.....	19
Switching the fan off	19
Switching the hob lighting on/off.....	20
Power management	20
Operation (Automatic and Manual modes)	21
Operating hours counters	21
Altering the operating hours counter for the grease filters	21
Activating and altering the charcoal filter operating hours counter	22
Reading the filter operating hours counter	22
Acoustic signal of the sensor controls	23
Cleaning and care	24
Casing.....	24
Important for appliances with glass surfaces	24
Grease filters	25
Resetting the grease filter operating hours counter	26
Charcoal filter.....	27
Resetting the charcoal filter operating hours counter.....	28
Disposing of the charcoal filters	28
Installation	29
Before installation	29
Assembly parts	29
Installation instructions	29
Appliance dimensions.....	30
Safety distance between hob and cooker hood (S).....	31

Contents

Installation recommendations	32
Electrical connection	33
Activating Con@ctivity 2.0	34
Installing the Con@ctivity 2.0 Stick	34
Activating Con@ctivity 2.0	34
Activating the cooker hood	34
Activating the hob	35
Activation check	35
After Sales / Guarantee	36
Position of the data plate	36
Guarantee: Other countries	36
Technical data	37
Conformity declaration	37

Warning and Safety instructions

This appliance complies with all relevant local and national safety requirements. Inappropriate use can, however, lead to personal injury and damage to property.

To avoid the risk of accidents and damage to the appliance, please read these instructions carefully before using it for the first time. They contain important notes on the safety, installation, use and maintenance of the appliance. Miele cannot be held liable for non-compliance with these instructions.

Keep these instructions in a safe place and ensure that all users are familiar with the contents. Pass them on to any future owner of the appliance.

Correct application

- ▶ This cooker hood is intended for use in domestic households and similar working and residential environments.
- ▶ The cooker hood is not intended for outdoor use.
- ▶ It must only be used as a domestic appliance to extract vapours and remove odours from cooking. Any other usage is not supported by the manufacturer and could be dangerous.
- ▶ The cooker hood can only be used by people with reduced physical, sensory or mental capabilities, or lack of experience and knowledge, if they are supervised whilst using it, or have been shown how to use it in a safe way and recognise and understand the consequences of incorrect operation.

Safety with children

- ▶ Children under 8 years of age must be kept away from the cooker hood unless they are constantly supervised.
- ▶ Children 8 years and older may only use the cooker hood unsupervised if they have been shown how to use it safely and recognise and understand the consequences of incorrect operation.
- ▶ Children must not be allowed to clean or maintain the cooker hood unsupervised.
- ▶ Please supervise children in the vicinity of the cooker hood and do not let them play with it.
- ▶ Danger of suffocation. Packaging, e.g. plastic wrappings, must be kept out of the reach of babies and children. Whilst playing, children could become entangled in packaging or pull it over their head and suffocate.

Warning and Safety instructions

Technical safety

- ▶ Unauthorised installation, maintenance and repairs can cause considerable danger for the user. Installation, maintenance and repairs must only be carried out by a Miele authorised technician.
- ▶ A damaged appliance can be dangerous. Check it for visible signs of damage. Do not use a damaged appliance.
- ▶ The electrical safety of this appliance can only be guaranteed when correctly earthed. It is essential that this standard safety requirement is met. If in any doubt please have the electrical installation tested by a qualified electrician.
- ▶ Before connecting the appliance to the mains supply, ensure that the connection data on the data plate (voltage and frequency) match the mains electricity supply. This data must correspond in order to avoid the risk of damage to the appliance. Consult a qualified electrician if in any doubt.
- ▶ Do not connect the appliance to the mains electricity supply by a multi-socket unit or an extension lead. These are a fire hazard and do not guarantee the required safety of the appliance.

Warning and Safety instructions

- ▶ For safety reasons, this appliance may only be used after it has been built in.
- ▶ The cooker hood must not be used in a non-stationary location (e.g. on a ship).
- ▶ Tampering with electrical connections or components and mechanical parts is highly dangerous to the user and can cause operational faults.
Only open the housing as described in the instructions given in the installation sheet and in the Cleaning and care section of this booklet. Under no circumstances should any other parts of the housing be opened.
- ▶ The manufacturer's warranty will be invalidated if the appliance is not repaired by a Miele approved service technician.
- ▶ Miele can only guarantee the safety of the appliance when genuine original Miele replacement parts are used. Faulty components must only be replaced by Miele spare parts.
- ▶ Do not pull on the mains connection cable. It must not be used for securing other components (such as a shelf).
- ▶ If the electrical connection cable is faulty it must only be replaced by a Miele authorised service technician to protect the user from danger.
- ▶ During installation, maintenance and repair work, the appliance must be disconnected from the mains electricity supply.

Warning and Safety instructions

Correct use

- ▶ Never use a naked flame beneath the cooker hood. To avoid the danger of fire, do not flambé or grill over a naked flame. When switched on, the cooker hood could draw flames into the filter. Fat deposits could ignite, presenting a fire hazard.
- ▶ The cooker hood can become damaged when exposed to excessive heat.
 - When using the cooker hood over a gas hob, ensure that any burners in use are always covered by a pan. Switch the cooking zone off when a pan is removed, even for a short time.
 - Select a pan which is suitable for the size of the burner.
 - Regulate the flame so that it does not burn up the sides of the pan.
 - Avoid overheating the pan (e.g. when cooking with a wok).
- ▶ Always switch the cooker hood on when a cooking zone is in use, otherwise condensation may collect in the hood, which could cause corrosion.
- ▶ When cooking with oil or fat, chip pans and deep fat fryers etc, do not leave the pans unattended. Never leave an open grill unattended when grilling. Overheated oil and fat can ignite and could set the cooker hood on fire.
- ▶ Do not use the cooker hood without the filters in place. This way you will avoid the risk of grease and dirt getting into the appliance and hindering its smooth operation.
- ▶ The filters should be regularly cleaned or changed as appropriate. Saturated filters are a fire hazard.
- ▶ The cooker hood can get very hot during cooking due to heat rising from the hob.
Do not touch the housing or the grease filters until the cooker hood has cooled down.

Correct installation

- ▶ Refer to the cooker or hob manufacturer's instructions as to whether a cooker hood may be operated above the cooker/hob.
- ▶ Safety regulations prohibit the fitting of a cooker hood over solid fuel stoves.
- ▶ Insufficient distance between the cooker or hob and the cooker hood can result in damage to the hood.
The minimum safety distances between the top of the cooker or hob and the bottom of the cooker hood given in the "Installation" section must be maintained, unless the hob manufacturer states that a greater distance is required.
If more than one cooking appliance is fitted beneath the cooker hood, and they have different minimum safety distances to the cooker hood, select the greater distance.
- ▶ The distances given in "Installation" must be observed when fitting the cooker hood.

Warning and Safety instructions

Cleaning and care

▶ Do not use a steam cleaning appliance to clean this appliance. The steam could reach electrical components and cause a short circuit.

Accessories

▶ Only use genuine original Miele accessories with this appliance. Using accessories from other manufacturers will invalidate the guarantee, and Miele cannot accept liability.

Disposal of the packing material

The packaging is designed to protect the appliance from damage during transportation. The packaging materials used are selected from materials which are environmentally friendly for disposal and should be recycled.

Recycling the packaging reduces the use of raw materials in the manufacturing process and also reduces the amount of waste in landfill sites.

Disposal of your old appliance

Electrical and electronic appliances often contain valuable materials. They also contain materials which, if handled or disposed of incorrectly, could be potentially hazardous to human health and to the environment. They are, however, essential for the correct functioning of your appliance. Please do not therefore dispose of it with your household waste.

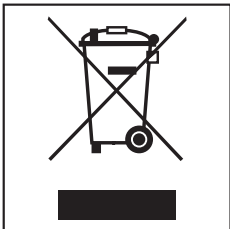

Please dispose of it at your local community waste collection / recycling centre or contact your Dealer for advice.

Ensure that it presents no danger to children while being stored for disposal.

Modes of operation

Recirculation mode

This cooker hood operates solely in recirculation mode.

The air is drawn in and cleaned first by the grease filters and then by four charcoal filters. The cleaned air is then recirculated back into the kitchen through ventilation grilles in the top of the cooker hood.

Con@ctivity 2.0 function

Automatic control

The cooker hood has a communication facility which enables the automatic operation of the cooker hood depending on the operational state of the hob.

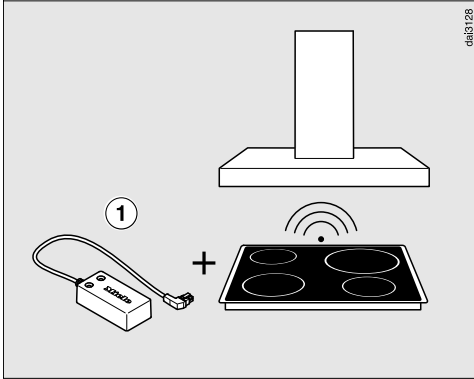

To make use of the communication facility the hob must be fitted with a Con@ctivity 2.0 Stick ①.

Refer to the installation instructions for the Con@ctivity 2.0 Stick to check whether it is compatible with your hob.

To use the Con@ctivity 2.0 function, a wireless connection must be established between the hob and the cooker hood (see "Activating Con@ctivity 2.0").

The hob transmits information about its operational status via a radio signal to the cooker hood.

- When the hob is switched on, the hob lighting comes on independently and then after a short time the fan also comes on.
- During cooking the cooker hood automatically sets the power level according to the number of cooking zones in operation and their power levels.
- After switching the hob off the fan and the hob lighting will switch off automatically after a specified period of time.

See "Operation" for detailed information about this function.

Guide to the appliance

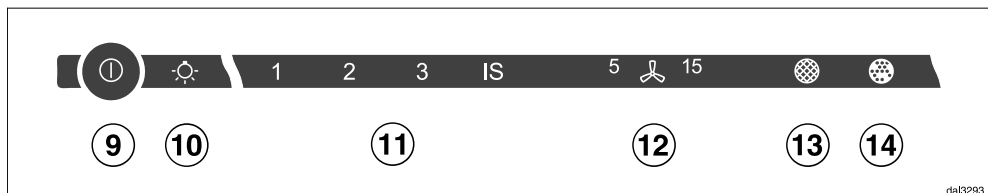
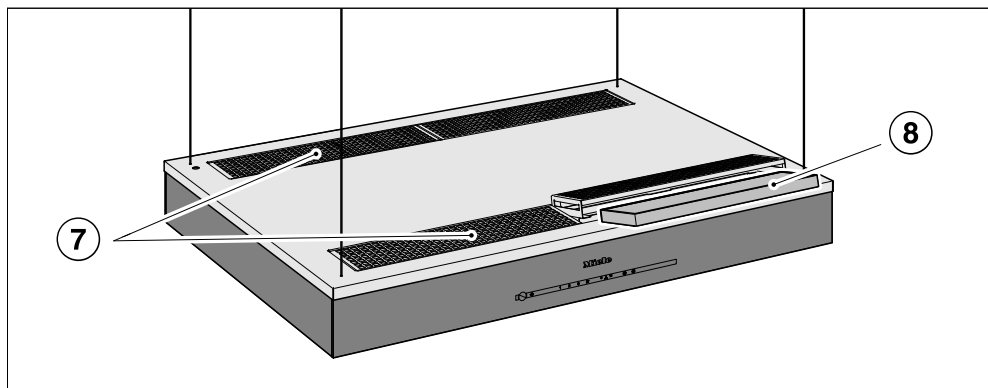
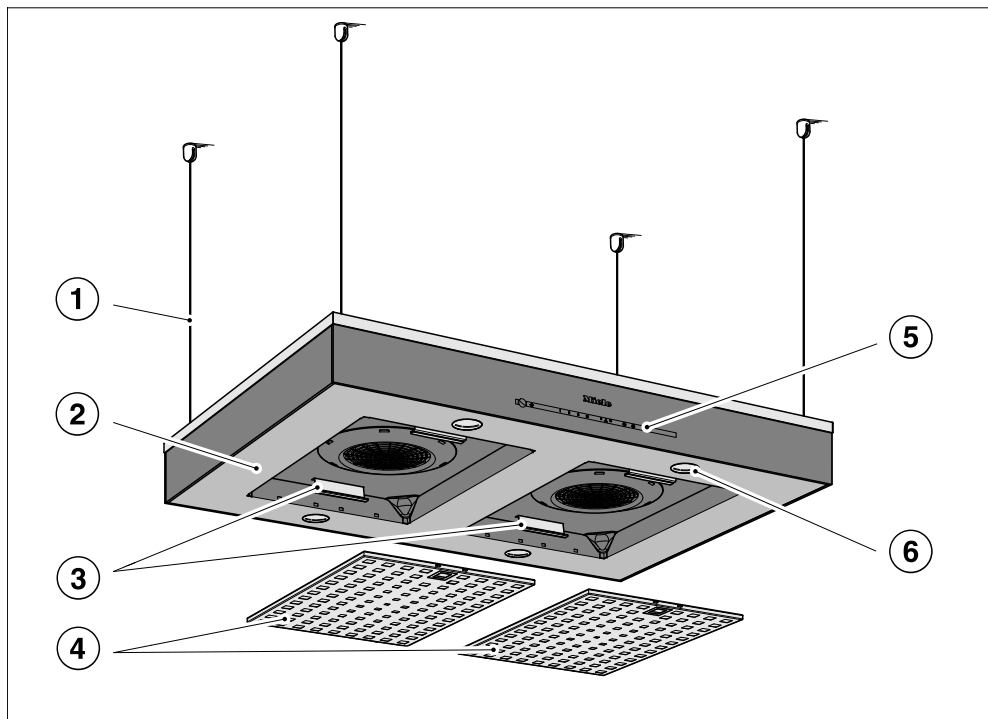

da13293

① Suspension cables

② Canopy

③ Grease filter clips

④ Grease filters

⑤ Controls

The symbols act as sensor controls. To select a function, touch the control. An audible tone sounds briefly to confirm selection.

⑥ Hob lighting

⑦ Recirculation grilles

⑧ Charcoal filters (x 4)

⑨ Sensor control for switching the fan on and off

⑩ Sensor control for hob lighting

⑪ Sensor controls for selecting the fan power level

⑫ Sensor control for the run-on option

⑬ Operating hours control for the grease filters

⑭ Operating hours control for the charcoal filters

Operation (Automatic mode)

When Con@ctivity 2.0 is activated, the cooker hood always works in automatic mode (see "Activating Con@ctivity 2.0").

To operate the cooker hood manually, see "Cooking without Con@ctivity 2.0".

Cooking with Con@ctivity 2.0 (Automatic mode)

- Switch a cooking zone on at the power level you want.

The cooker hood lighting will come on.

After a few seconds the fan will come on, first at power level **2**, then it will switch immediately to power level **1**.

The cooker hood selects the power level automatically during cooking.

This is determined by the total output of the hob, i.e, the number of cooking zones in operation and the power levels selected.

- If you select a higher power level or are using several cooking zones, the cooker hood will switch to a higher power level.
- When you reduce the power level or the number of cooking zones on the hob, the cooker hood power level is also reduced.

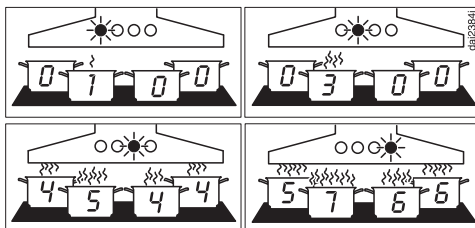

Examples for power levels **1** to **4**

Reaction time

The cooker hood reacts with a slight delay because altering the power level on the hob does not immediately result in a reduction or increase in cooking vapours.

Because the hob transmits the information to the cooker hood at intervals, this can also cause delays.

The reaction can vary from a few seconds to a couple of minutes.

Cooking process

- If for example you switch on a cooking zone at the highest power level to heat a pan for frying and reduce the power level after approx. 60 to 90 seconds*, a cooking process is recognised (*60 seconds to 5 minutes for a HiLight hob).

The cooker hood switches itself on and when the hob power level has been reduced, the hood switches to power level 3 and remains at that level for approx. 5 minutes.

After that the cooker hood power level is determined automatically by the Con@ctivity function.

- You can select another power level manually before then.

Switching off

- Switch off all cooking zones.

The cooker hood fan will reduce its power level over the next few minutes and will eventually switch itself off.

This helps to neutralise any lingering vapours and odours in the air.

- From the intensive setting IS the fan switches immediately to level 3.
- From level 3, it switches to level 2 after approx. 1 minute.
- From level 2 it switches to level 1 after approx. 2 minutes.
- After 2 minutes at level 1 the fan switches itself off.
- After another 30 seconds the lighting switches off.

The cooking process is then finished.

Operation (Automatic mode)

Leaving automatic mode temporarily

To leave automatic mode temporarily during cooking:

- Manually select a different power level, or
- Manually switch the cooker hood off, or
- Activate the run-on option  on the cooker hood. The fan will switch off after the selected time and the lighting remains switched on.

The cooker hood can now be operated manually (see "Cooking without Con@ctivity 2.0").

Returning to automatic mode

The cooker hood returns to automatic mode:

- if the cooker hood has not been used for approx. 5 minutes after selecting a power level manually, or
- if the manually selected fan power level corresponds to the automatic one again, or
- if the cooker hood fan and the hob have been switched off for at least 30 seconds.
Automatic mode will resume next time the hob is switched on.
- If you wish to operate the cooker hood manually for a complete cooking process, switch on the cooker hood fan **before** switching on the hob.
If the cooker hood and the hob have been switched off for at least 30 seconds after cooking, automatic mode will resume the next time the hob is switched on.

Cooking without Con@ctivity 2.0 (Manual mode)

The cooker hood can be operated manually if:

- Con@ctivity 2.0 is not activated.
- You have temporarily deactivated Con@ctivity 2.0 (see "Leaving automatic mode temporarily").

Switch the fan on

- Touch the On/Off sensor ①.

The fan will come on at power level **2**.

Select the power level

For light to heavy cooking vapours and odours, select from power levels **1** to **3**.

When frying or cooking food with a very strong aroma, select the Intensive setting **IS**.

- Select the power level required by touching a control from **1** to **IS**.





Reducing power on the intensive setting

If Power management is activated (default), the fan automatically switches to level **3** after 5 minutes.

Selecting the run-on time

It is advisable to run the fan for a few minutes after cooking has finished to neutralise any lingering vapours and odours in the air.

With the run-on option the fan switches itself off automatically after a pre-selected time.

- After you have finished cooking, touch the run-on option control .
- Once: the fan will switch itself off after 5 minutes (**5**  lights up).
- Twice: The fan will switch itself off after 15 minutes ( **15** lights up).
- If you touch the run-on option control  again, the fan will remain on (**5**  **15** will go out).

Switching the fan off

- Use the On/Off control ① to switch the fan off.

Operation (Manual mode)

Switching the hob lighting on/off

The hob lighting can be switched on and off independently of the fan.



- Touch the hob lighting control .

Power management

The cooker hood features a power management system for switching off the lighting and reducing the fan power level automatically.

- If the Intensive setting has been selected the cooker hood will automatically switch down to power level 3 after 5 minutes.
- From levels 3, 2 or 1 the power will be reduced by one level after 2 hours and then in 30 minutes stages until the fan finally switches off.
- The hob lighting will switch off automatically after 12 hours.

Switching Power management on/off

- Switch off the fan and the lighting.
- Touch the run-on option control  for approx. 10 seconds, until **1** lights up in the power level display.
- Then touch in turn,
 - the lighting control ,
 - the **1** and then
 - the lighting control  again.

If Power management is switched on, the **1** and **IS** indicators will light up constantly.

If it is switched off, **1** and **IS** will flash.

- Touch **1** to switch Power management off.

The **1** and **IS** indicators will flash.

- Touch **IS** to switch it on.

The **1** and **IS** indicators will light up constantly.

- Confirm the setting with the run-on option control .



All the indicator lamps will go out

If you do not confirm within 4 minutes, the cooker hood will revert to the old setting.

Operation (Automatic and Manual modes)

Operating hours counters



The number of hours the appliance has been in operation is stored in memory.

When the Grease filter symbol  or the Charcoal filter symbol  lights up, the operating hours counters are signalling that the filters need to be cleaned or changed. Further information about cleaning and changing the filters and resetting the operating hours counter can be found under "Cleaning and care".

Altering the operating hours counter for the grease filters

You can set the operating hours counter for the grease filter to suit the type of cooking you do.

The grease filter operating hours counter is set at the factory for 30 hours.

- Select a shorter time of 20 hours if you fry a lot.
- If you only cook occasionally we recommend that you still select a short time because grease which has built up gradually over a long period of time will harden on the filter and make cleaning more difficult.
- Select a longer time of 40 or 50 hours if you use very little fat for cooking.
- Use the On/Off control  to switch the fan off.
- Touch the run-on option control  and the Grease filter sensor  at the same time.

The Grease filter symbol  and one of the fan power level indicators will flash.

Fan power level indicators **1** to **IS** show the time set:

- 1**..... 20 hours
- 2**..... 30 hours
- 3**..... 40 hours
- IS** 50 hours

- Touch the relevant sensor to select the duration required.
- Confirm your choice by touching the Grease filter control .

All the indicator lamps will go out



If you do not confirm within 4 minutes, the cooker hood will revert to the old setting.

Operation (Automatic and Manual modes)

Activating and altering the charcoal filter operating hours counter

Charcoal filters are needed for recirculation mode.

The operating hours counter for the charcoal filter needs to be activated once and the operating hours counter needs to be set to suit the kind of cooking you do:

- Use the On/Off control  to switch the fan off.
- Touch the run-on option control  and the Charcoal filter control  at the same time.

The Charcoal filter symbol  and one of the fan power levels will flash.

Fan power level indicators **1** to **IS** show the time set:

1	120 hours
2	180 hours
3	240 hours
IS	Deactivated



- Touch the relevant sensor to select the duration required.
- Confirm your choice by touching the Charcoal filter control .

All the indicator lamps will go out.

If you do not confirm within 4 minutes, the cooker hood will revert to the old setting.

Reading the filter operating hours counter

To check the percentage of time set already used

- Touch the On/Off control  to switch the fan on.
- Press and hold the Grease filter control  or the Charcoal filter control .

One or more of the power level indicators will flash.

The number of fan power level indicators flashing shows the percentage of the operating time which has already been used up.



1	25 %
1 and 2	50 %
1 to 3	75 %
1 to IS	100 %

The number of operating hours used remains in the memory, even when the appliance is switched off or there is a power cut.

Acoustic signal of the sensor controls

When selecting a function with the sensor controls an acoustic signal will sound for confirmation.

The acoustic signal can be deactivated.

- Use the On/Off control  to switch the fan off.
- Touch the **IS** and the Grease filter  controls at the same time for approx. 5 seconds until a short acoustic signal is heard.

The acoustic signal function is now switched off.

- To reactivate the acoustic signal, follow the steps as per deactivating the signal.

When power is restored to the cooker hood after it has been disconnected from the mains electricity supply or after a power cut, the acoustic signal will be activated again, regardless of the previous setting.

Cleaning and care

Casing

General information

The surfaces and controls are susceptible to scratches and abrasion.

Please observe the following cleaning instructions.

- All external surfaces and controls can be cleaned using hot water with a small amount of washing-up liquid applied with a well wrung-out soft sponge or cloth.
- After cleaning, wipe the surfaces dry using a soft cloth.

Do not use:

- cleaning agents containing soda, acids, chlorides or solvents,
- abrasive cleaning agents, e.g. powder cleaners or cream cleaners and abrasive sponges, as well as pot scourers or sponges which have been used previously with abrasive cleaning agents. These will damage the surface material.

Important for appliances with stainless steel surfaces

- Stainless steel surfaces can be cleaned with a proprietary non-abrasive cleaning agent designed specifically for use on stainless steel.
- To help prevent re-soiling, a proprietary conditioning agent for stainless steel (available from Miele) can also be used. Follow the manufacturer's instructions on the packaging.

Important for appliances with lacquered housing

- Please observe the general notes on cleaning earlier in this section.

It is very difficult to clean this type of surface without causing minor marks to the surface material. This can become particularly noticeable if there is halogen lighting in the kitchen.

Important for appliances with glass surfaces

- Glass surfaces can be cleaned using a proprietary non-abrasive cleaning agent designed specifically for use on glass.

Grease filters

The re-usable metal grease filters in the appliance remove solid particles (grease, dust, etc.) from the kitchen vapours, preventing soiling of the cooker hood.

 An oversaturated filter is a fire hazard.

Cleaning interval

The grease filters should be cleaned regularly (at least every 3 - 4 weeks) to avoid a build-up of grease.

Clean them immediately if the Grease filter operating hours symbol  lights up.

- You can set the operating hours counter for the grease filters to suit the type of cooking you do (see "Operation").

Removing a grease filter

The grease filter can fall out when you are handling it.

This can result in damage to the filter and the hob below.

Make sure you hold the filter securely at all times when handling it.

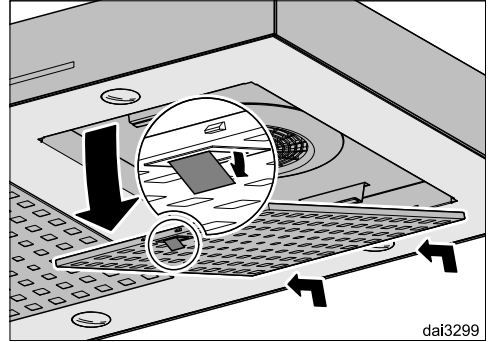

- To take out a grease filter, release the locking clip on the filter, lower the filter approx. 45°, unhook it at the back and remove it.

Cleaning the grease filters by hand

- Clean the filters with a soft nylon brush in a mild solution of hot water and a small amount of washing-up liquid. Do not use "neat" washing up liquid.

Unsuitable cleaning agents

Unsuitable cleaning agents can cause damage to the surface of the filters if used regularly.

Do not use:

- cleaning agents containing descaling agents
- powder cleaners, cream cleaners
- aggressive multi-purpose cleaning agents or spray cleaners for grease
- oven sprays

Cleaning and care

Cleaning the grease filters in the dishwasher

- Place the filters as upright as possible in the lower basket, with the short sides upright, ensuring the spray arm is not obstructed.
- Use a proprietary household dishwasher detergent.
- Select a dishwasher programme with a wash temperature between 50°C and 65°C.

Depending on the cleaning agent used, cleaning the filters in a dishwasher can cause permanent discolouration to the surface. However, this will not affect the functioning of the filters in any way.

After cleaning

- After cleaning, leave the filters to dry on an absorbent surface before replacing them.
- When removing the filters for cleaning, also clean off any residues of oil or fat from the now accessible housing to prevent the risk of these catching fire.
- Replace the grease filters, making sure that the locking clips are facing down towards the hob.

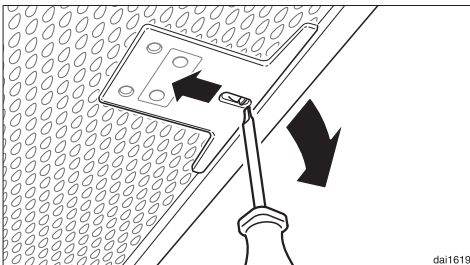

- If a grease filter is inadvertently replaced upside down, insert a small screwdriver blade into the slit to disengage the clip.

Resetting the grease filter operating hours counter

After cleaning, the operating hours counter needs to be re-set.

- Whilst the fan is switched on, press the Grease filter control  for approx. 3 seconds, until only the **1** is flashing.

The Grease filter symbol  goes out.

If you want to clean the grease filters before the operating hours counter has reached its maximum,

- Touch the Grease filter control  for approx. 6 seconds, until only the **1** is flashing.

Charcoal filter

With recirculation mode, four charcoal filters must be fitted in the grease filters. These are designed to absorb cooking odours.

They are fitted into the canopy from above.

Charcoal filters can be obtained from your Miele dealer or via the internet at www.miele-shop.com. See back of manual for contact details, and "Technical data" for type and reference number.

Fitting and replacing a charcoal filter

- Before fitting or replacing a charcoal filter, the grease filters must first be taken out (see previous section for instructions on how to do this).
- Take the charcoal filters out of their packaging.

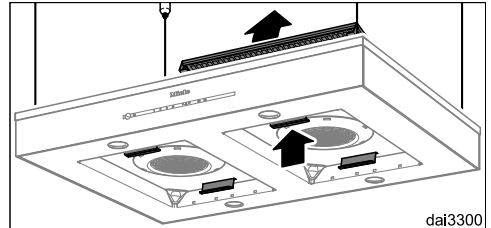

- Open the holders for the charcoal filters.

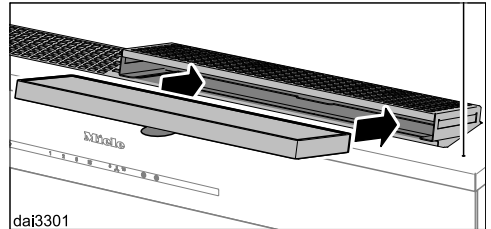

- Insert the charcoal filters and close the holders.
- Replace the grease filters.
- When fitting for the first time, activate the operating hours counter (see "Operation").

Cleaning and care

When to change the charcoal filter

- Always replace the charcoal filters when they no longer absorb kitchen odours effectively. They should, however, be replaced at least every 2 years.

The charcoal filter operating hours symbol  will light up to remind you to change the charcoal filters.

- The charcoal filter operating hours counter needs to be activated before using for the first time (see "Operation").

Resetting the charcoal filter operating hours counter

After changing the charcoal filters, the operating hours counter needs to be reset.

- Touch the Charcoal filter control  for approx. 3 seconds with the cooker hood switched on until only the indicator light for level 1 is flashing.

The Grease filter symbol  will go out.

If you want to replace the charcoal filters **before** the operating hours counter has reached its maximum:

- Touch the Charcoal filter control  for approx. 6 seconds until only the indicator light for level 1 is flashing.

Disposing of the charcoal filters

- Used charcoal filters can be disposed of with the normal household waste.

Before installation

 Before installation, it is important to read the information given on the following pages as well as the "Warning and Safety instructions" at the beginning of this booklet.

Assembly parts

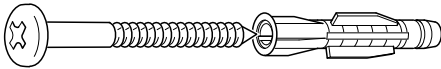

4 screws 5 x 60 mm and
4 plugs 8 x 50 mm

For securing to the ceiling.

The screws and plugs are suitable for use in concrete ceilings. For other types of ceiling construction, alternative fixings will be required.

Make sure the ceiling is able to take the weight of the cooker hood.

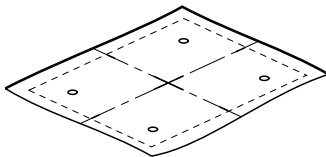

Drilling template

One of the cardboard inserts serves as the drilling template.

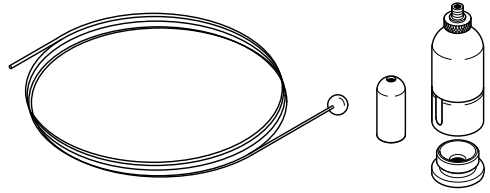

4 sets of ceiling fixings

For suspending the cooker hood from the ceiling. Set contains 4 cables, 4 casing fixings and 4 ceiling fixings.

The cables must not be used for securing other components such as a shelf.

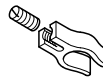

3 cable clamps

For securing the mains connection cable to one of the suspension cables.



1 strain relief

For securing the mains connection cable to one of the ceiling fixings.

Installation instructions

See enclosed Installation sheet for instructions on how to install this appliance.

Installation

Appliance dimensions

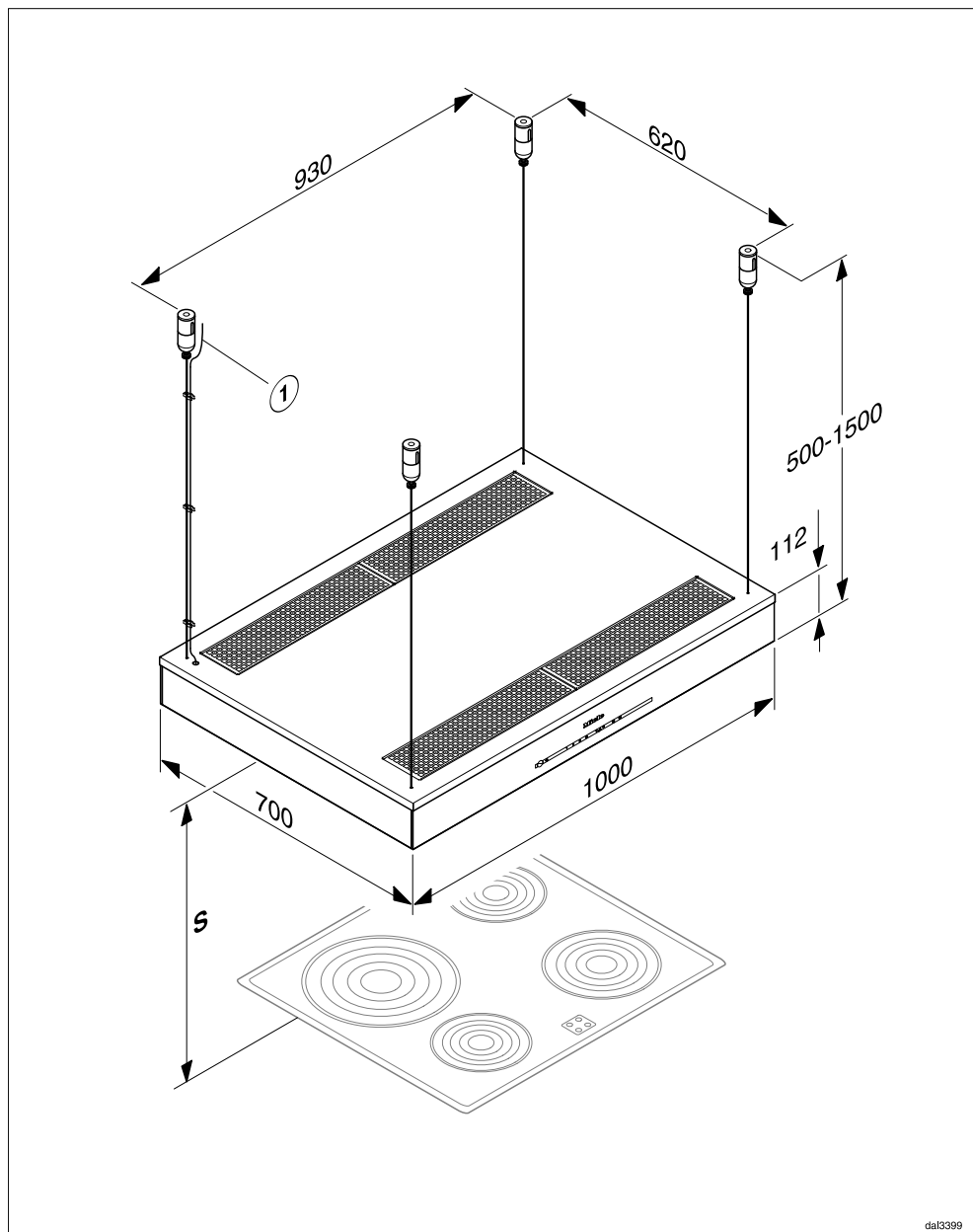

① Mains connection cable

Safety distance between hob and cooker hood (S)

When planning the installation height of your cooker hood, the minimum safety distance between the top of a cooker or hob and the bottom of the cooker hood is as follows, unless a greater distance is specified by the manufacturer of your cooking appliance.

See "Warning and Safety" instructions for further information.

Cooking appliance	Minimum distance S
Electric hob	450 mm
Electric grill	650 mm
Deep fat fryer (electric)	650 mm
Multi-burner gas hob with a maximum total output of 12.6 kW, no burner exceeding 4.5 kW.	650 mm
Multi-burner gas hob with a total output of more than 12.6 kW, or a multi-burner gas hob where one burner exceeds 4.5 kW.	760 mm
Single gas burner with a maximum output of 6 kW.	650 mm
Single gas burner with output exceeding 6 kW.	760 mm

Installation

Installation recommendations

- When deciding on the safety distance between the hob and cooker hood, please note that a distance of 650 mm above electric cookers/hobs may be preferable to give more working space under the hood.
- Account should also be taken of the height of the person who will be using the hood most often. They should have sufficient space to work comfortably at the hob, and be able to reach the hood controls with ease.
- Please be aware that if positioned too high, extraction will be inefficient.
- To achieve optimum vapour extraction, the cooker hood must cover the hob. It should be positioned centrally over the hob, not to the side or to the back of it.
- The hob should be no wider than the cooker hood, and if possible, it should be narrower.
- The installation area must be easily accessible. The cooker hood should be easily accessible and easy to dismantle in the event that service is required. This should be taken into consideration when planning the position of cupboards, shelves, ceilings or features in the vicinity of the cooker hood.

All electrical work should be undertaken by a suitably qualified and competent person in strict accordance with current national and local safety regulations (BS 7671 in the UK).

Installation, repairs and other work by unqualified persons could be dangerous, for which the manufacturer cannot be held liable. Ensure power is not supplied to the appliance until after installation or repair work has been carried out. Do not connect the appliance to the mains electricity supply by an extension lead. These do not guarantee the required safety of the appliance.

The connection data is given on the data plate. This is visible when the grease filters have been removed. Ensure that this data matches the household mains supply.

Connection of this appliance should be made via a suitable isolator or a double pole fused spur connection unit which complies with national and local safety regulations and the On-Off switch should be easily accessible after the appliance has been built in. When switched off there must be an all-pole contact gap of 3 mm in the switch (including switch, fuses and relays according to EN 60335).

If the switch is not accessible after installation (depending on country), an additional means of disconnection must be provided for all poles.

For extra safety it is advisable to protect the appliance with a suitable residual current device (RCD). Contact a qualified electrician for advice.

Important

This appliance is supplied for connection to an a.c. 230 V single phase 50 Hz supply. The wires in the mains lead are coloured in accordance with the following code:

Green/yellowearth
Blue.....neutral
Brownlive

**WARNING:
THIS APPLIANCE MUST BE
EARTHED**

Activating Con@ctivity 2.0

Installing the Con@ctivity 2.0 Stick

In order to use the Con@ctivity 2.0 function, the hob must first be fitted with the Con@ctivity 2.0 Stick.

- Please read the separate installation instructions supplied with the Con@ctivity 2.0 Stick.

Activating Con@ctivity 2.0

Wireless connection must be activated between the cooker hood and the hob before Con@ctivity 2.0 can be used.



Both appliances must be installed and operational.

You only need to carry out the activation procedure once. If the appliances are disconnected from the electricity supply, during a power cut for example, they will still remain activated.

To establish the wireless connection, the cooker hood and hob must be activated at the same time.

First activate the cooker hood, then the hob.

Activating the cooker hood

- Switch off the fan, hob lighting and hob.
- Touch the run-on option control  for approx. 10 seconds, until **1** lights up in the power level display.
- Then touch in turn,
 - the **1** control,
 - then the **IS** control,
 - then the lighting control .

If Con@ctivity 2.0 has not been activated, the indicators for levels **2** and **3** will flash at the same time.

- To activate Con@ctivity 2.0 touch the **IS** control.
- 2** will light up constantly and **3** will flash. The search for a signal starts.
- Meanwhile, start the activation of the hob.

Activating the hob

- **While** the cooker hood is searching for a signal, start activating the hob. More information about this can be found in the operating instructions for the hob.

When connection has been established, **2** and **3** will light up constantly on the cooker hood.



- Confirm activation of the cooker hood with the run-on option control **5**  **15**. All indicators will go out.
- Confirm activation of the hob.

Con@ctivity 2.0 is now ready to use.

If you do not confirm your selection within 4 minutes, activation will not take place.

Activation check

To check whether Con@ctivity 2.0 has been activated for the cooker hood:

- Switch off the fan and hob lighting.
- Touch the run-on option control  for approx. 10 seconds, until **1** lights up in the power level display.
- Then touch in turn,
 - the **1** control,
 - then the **IS** control,
 - then the lighting control .

If Con@ctivity 2.0 has been activated, the indicators for levels **2** and **3** will be lit up constantly.

If Con@ctivity 2.0 has not been activated, the indicators for levels **2** and **3** will flash at the same time.

- To come out of checking mode, touch the run-on option control . All indicators will go out.
- To check whether Con@ctivity has been activated on the hob, see the operating instructions for the hob.
- If connection cannot be established despite activating the Con@ctivity function on the cooker hood and hob, the function must be deactivated on both appliances and then the procedure repeated.

After Sales / Guarantee

In the event of a fault which you cannot remedy yourself, please contact your Miele dealer or the Miele Service Department.

Contact details for Miele are given at the back of this manual. N.B. A call-out charge will be applied to service visits where the problem could have been resolved as described in these instructions.

When contacting your dealer or Miele, please quote the model and serial number of your appliance. These are shown on the data plate.

Position of the data plate

The data plate is visible after removing the grease filters.

Guarantee: U.K.

In the U.K., the appliance is guaranteed for 2 years from the date of purchase. However, you must activate your cover by calling 0845 365 6640 or registering online at www.miele.co.uk.

Guarantee: Other countries

For information on the appliance guarantee specific to your country please contact Miele. See end of this booklet for contact details.

Technical data

Fan motor	2 x 72 W
Hob lighting	4 x 3 W
Total connected load	156 W
Voltage	AC 230 V
Fuse rating	5 A
Mains connection cable length	1.8 m
Weight	33 kg
Recirculation power*	
Level 1	250 m ³ /h
Level 2	350 m ³ /h
Level 3	450 m ³ /h
Intensive setting	600 m ³ /h

*Recirculation mode with charcoal filters DKF 21

Conformity declaration

Miele hereby declares that the cooker hoods listed at the end of this booklet comply with the basic requirements and other relevant regulations of Guideline 1999/5/EC.

A copy of the full Declaration of Conformity can be obtained from the address at the end of this booklet.

United Kingdom

Miele Co. Ltd.
Fairacres, Marcham Road
Abingdon, Oxon, OX14 1TW
Tel: 0845 365 0555
Customer Contact Centre Tel: 0845 365 6600
E-mail: info@miele.co.uk
Internet: www.miele.co.uk

Australia

Miele Australia Pty. Ltd.
ABN 96 005 635 398
1 Gilbert Park Drive, Knoxfield, VIC 3180
Tel: 1300 464 353, Fax: (03) 9764 7149
Internet: www.miele.com.au

China

Miele (Shanghai) Trading Ltd.
1-3 Floor, No. 82 Shi Men Yi Road
Jing' an District
200040 Shanghai, PRC
Tel: +86 21 6157 3500, Fax: +86 21 6157 3511
E-mail: info@miele.cn, Internet: www.miele.cn

Miele (Hong Kong) Limited

41/F - 4101, Manhattan Place
23 Wang Tai Road
Kowloon Bay, Hong Kong
Tel: (852) 2610 1331, Fax: (852)2610 1013
Email: mielehk@miele.com.hk

India

Miele India Pvt. Ltd.
Ground Floor, Copia Corporate Suites
Plot No. 9, Jasola
New Delhi - 110025
Tel: 011-46 900 000, Fax: 011-46 900 001
E-mail: customercare@miele.in, Internet: www.miele.in

Ireland

Miele Ireland Ltd.
2024 Bianconi Avenue
Citywest Business Campus, Dublin 24
Tel: (01) 461 07 10, Fax: (01) 461 07 97
E-Mail: info@miele.ie, Internet: www.miele.ie

Manufacturer: Miele & Cie. KG

Carl-Miele-Straße 29, 33332 Gütersloh, Germany

Miele

Malaysia

Miele Sdn Bhd
Suite 12-2, Level 12
Menara Sapura Kencana Petroleum
Solaris Dutamas No. 1, Jalan Dutamas 1
50480 Kuala Lumpur, Malaysia
Phone: +603-6209-0288
Fax: +603-6205-3768

New Zealand

Miele New Zealand Limited
8 College Hill
Freemans Bay, Auckland 1011, NZ
Tel: 0800 464 353, Fax: +64 9378 0146
Internet: www.miele.co.nz

Singapore

Miele Southeast Asia
Miele Pte. Ltd.
163 Penang Road
04 - 02/03 Winsland House II
Singapore 238463
Tel: +65 6735 1191, Fax: +65 6735 1161
E-Mail: infosea@miele.com.sg
Internet: www.miele.sg

South Africa

Miele (Pty) Ltd
63 Peter Place, Bryanston 2194
P.O. Box 69434, Bryanston 2021
Tel: (011) 875 9000, Fax: (011) 875 9035
E-mail: info@miele.co.za
Internet: www.miele.co.za

United Arab Emirates

Miele Appliances Ltd.
P.O. Box 11 47 82
Gold & Diamond Park
Sheikh Zayed Road
Building 6 / Offices Nos. 6-214 to 6-220
Dubai
Tel: +971-4-341 84 44
Fax: +971-4-341 88 52
E-Mail: info@miele.ae
Internet: www.miele.ae

DA 6700 D



en-GB

M.-Nr. 09 767 780 / 01